

X-TRAC

*premium-hebebühne
speziell entwickelt für leichte und
schwere reparaturen*



LIFTING CAPACITY

4000 KG

10 TON

PULLING CAPACITY



WWW.CELETTE.COM | INFO@CELETTE.COM



X-TRAC

HEBE- UND ZIEHPLATTFORM - EMPFOHLEN FÜR LEICHTE UND MITTLERE REPARATUREN

REF NO: XT14.3000.x | XT14.3600.x | XT14.3800.x

Die NEUE X-TRAC mit 4000 kg Hub- und 10 Tonnen Zugkraft

X-TRAC ist eine Hebebühne, die speziell für leichte und mittlere Reparaturen entwickelt wurde. Sobald das Fahrzeug auf der Plattform positioniert ist, kann es einfach und schnell an den Rädern angehoben werden, um dem Techniker Zugang zu den Verankerungspunkten zu verschaffen. X-TRAC hat eine zweite Funktion und kann als Scherenhebebühne für Sevenne Richtbank verwendet werden.

SMART | SCHNELL | EINFACH

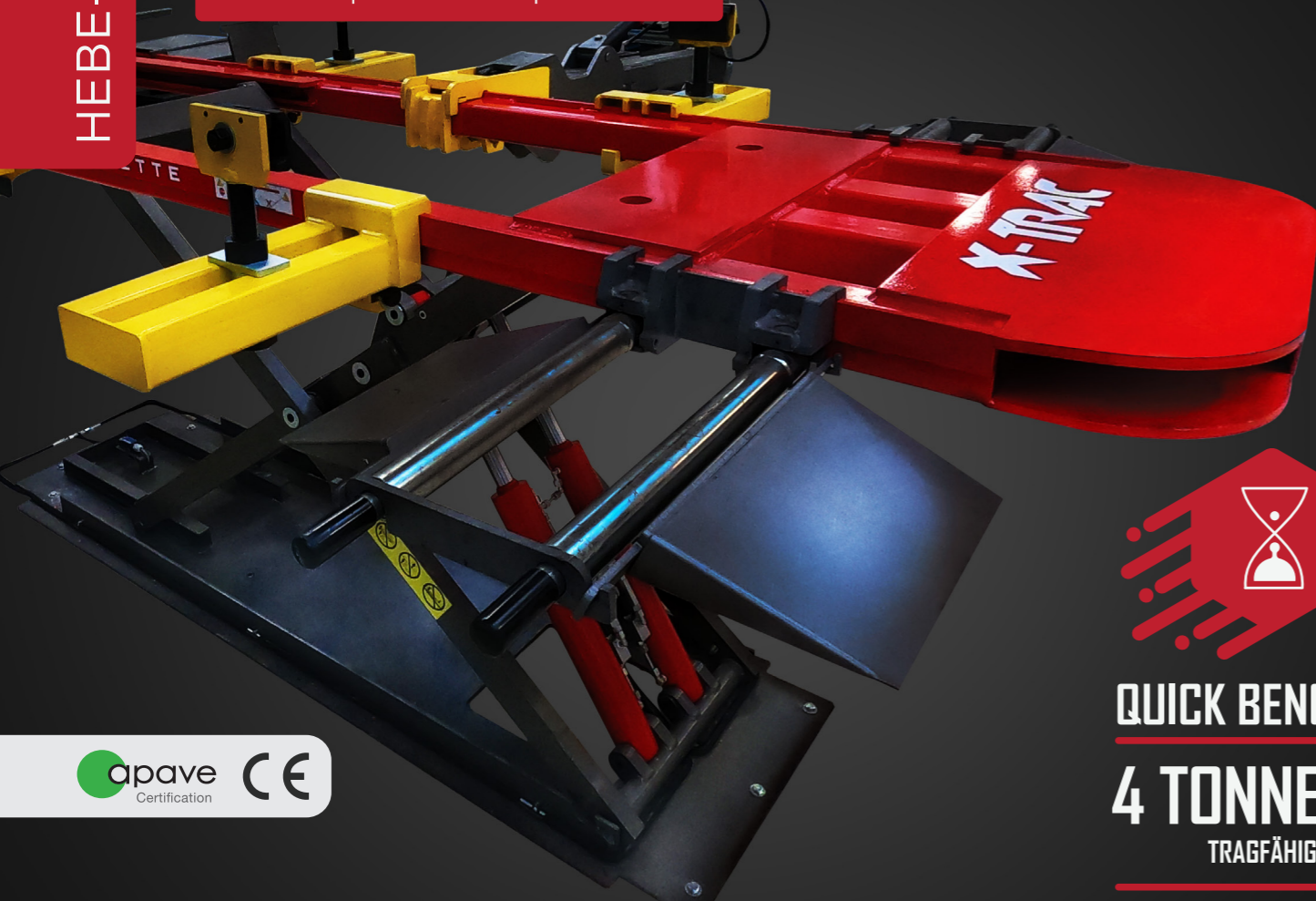

QUICK BENCH

4 TONNEN
TRAGFÄHIGKEIT

360°

OBERANSICHT

Regular

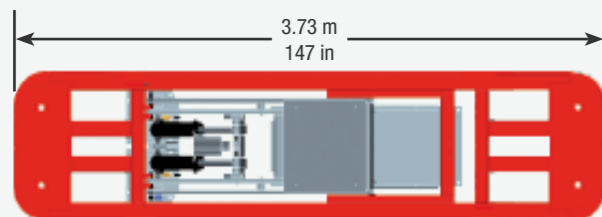

9200.20

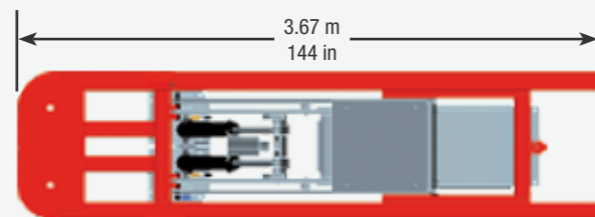

9200.01

STANDARD



XT14.1800.x

2 SÄTZE

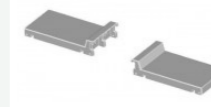

XT14.0600



XT14.0613



X110.0400



XT14.0614

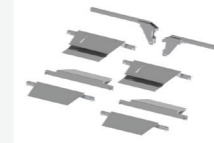

XT14.0605

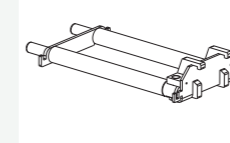

XT14.0601



LX02.0606

BASIC



XT14.1800.x

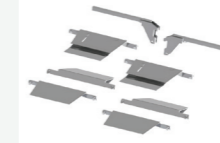

XT14.0605

3 SÄTZE

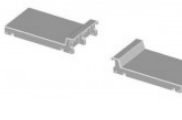

XT14.0600

RAPID



XT14.1800.x

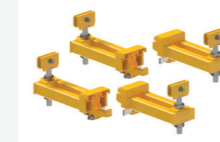

X110.0400

3 SÄTZE

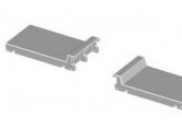

XT14.0600



XT14.0613

2 SÄTZE



LX02.0602



XT14.0610



XT14.0614

REFERENZNUMMER	BESCHREIBUNG
XT14.3800.x	X-TRAC STANDARD
XT14.3000.x	X-TRAC BASIC
XT14.3600.x	X-TRAC RAPID

X-TRAC

HEBE- UND ZIEHPLATTFORM - EMPFOHLEN FÜR LEICHTE UND MITTLERE REPARATUREN

REF NO: XT14.3800.x | XT14.3500.x | XT14.3600.x

DIE NEUE X-TRAC mit 4000 kg Hub- und 10 Ton Tonnen Zugkraft

- ⊕ Die Sevenne Richtbank auf Rädern kann bequem auf der X-TRAC manövriert werden, um die gewünschte Arbeitshöhe zu erreichen.
- ⊕ Im Falle des Austauschs von Bauteilen ermöglicht X-TRAC eine bequeme Hubhöhe für das Auftragen der Zinkgrundierung, das Kleben, Nieten und einfache Inspektionen.
- ⊕ X-TRAC bietet eine bessere Arbeitshöhe beim Schneiden und Schweißen, während das Fahrzeug auf Sevenne stabil verankert ist.

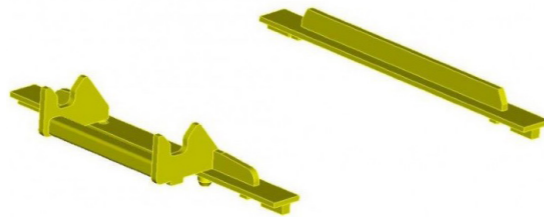

OPTIONAL

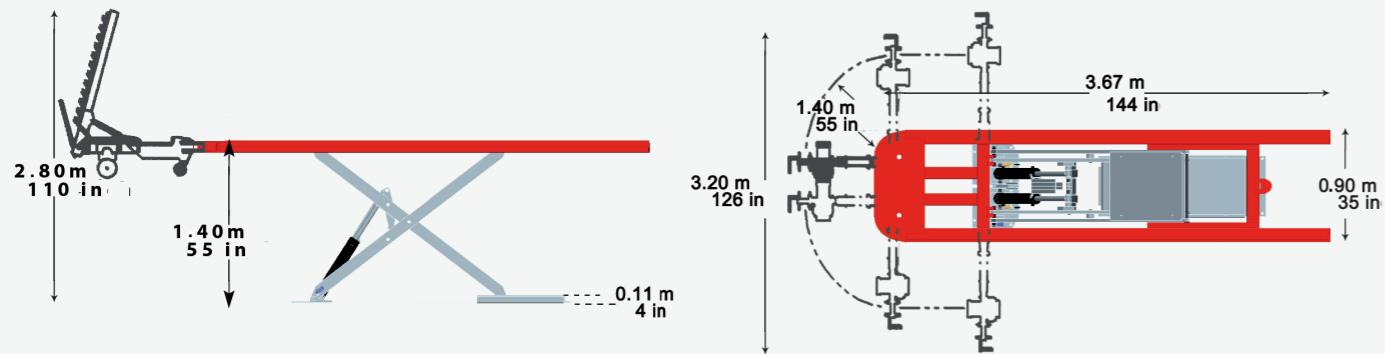

Weight : 1064 Kg / 2346 lbs

X-TRAC

HEBE- UND ZIEHPLATTFORM - EMPFOHLEN FÜR LEICHTE UND MITTLERE REPARATUREN

REF NO: XT14.3800.x | XT14.3500.x | XT14.3600.x

OPTIONAL



REF NO: XT14.3800.x

X-TRAC
STANDARD

REF NO: XT14.3000.x

X-TRAC
BASIC

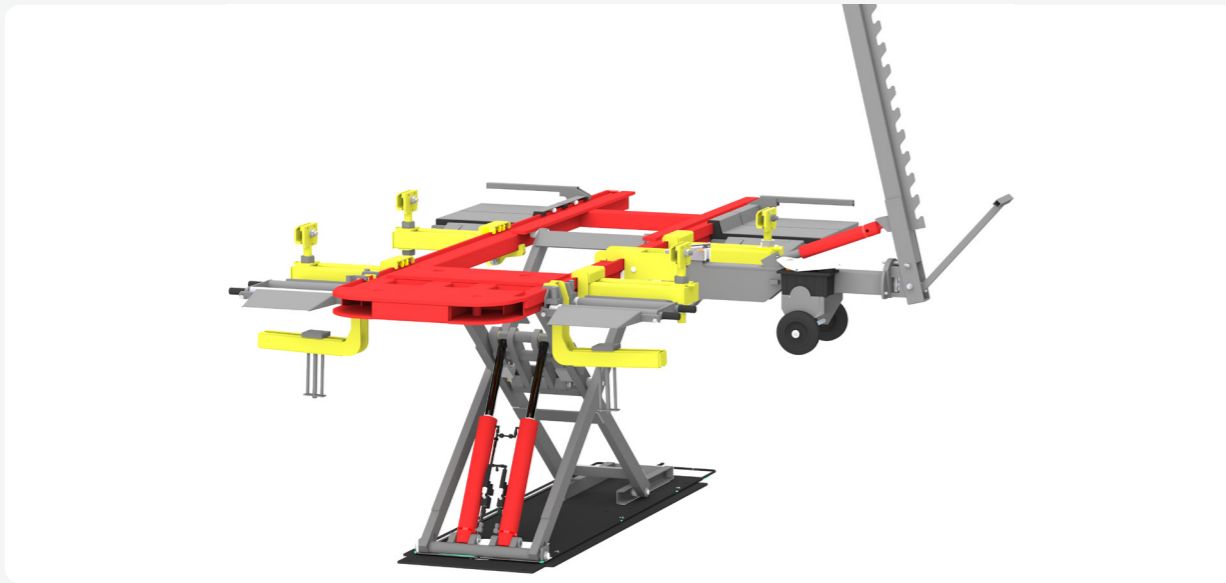

2 SÄTZE



XT14.0600



XT14.0613



X110.0400

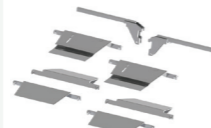

XT14.0605



XT14.0614

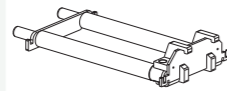

XT14.0601



LX02.0606

REFERENZNUMMER	BESCHREIBUNG
XT14.3800.x	X-TRAC STANDARD
REFERENZNUMMER	ZUBEHÖR
XT14.1800.x	HEBETISCH
X110.0400	SCHWELLERKLAMMERN
XT14.0600	STARRE BELAGPLATTEN (X2)
XT14.0613	ZUGGERÄT
XT14.0614	ZUBEHÖR FÜR SEITLICHES ZIEHEN
XT14.0605	6 MINI-RAMPEN ZUSAMMENSETZUNG
XT14.0601	RADSTÜTZE ZUM ÖFFNEN (X2)
LX02.0606	RADPOSITIONIERER



3 SÄTZE

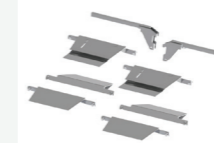

XT14.0605

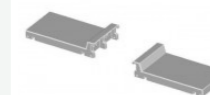

XT14.0600

REFERENZNUMMER	BESCHREIBUNG
XT14.3000.x	X-TRAC BASIC
REFERENZNUMMER	ZUBEHÖR
XT14.1800.x	HEBETISCH
XT14.0600	SATZ MIT 2 RIGID BASKETS
XT14..0605	6 MINI-RAMPEN ZUSAMMENSETZUNG

REF NO: XT14.3600.x

X-TRAC
RAPID

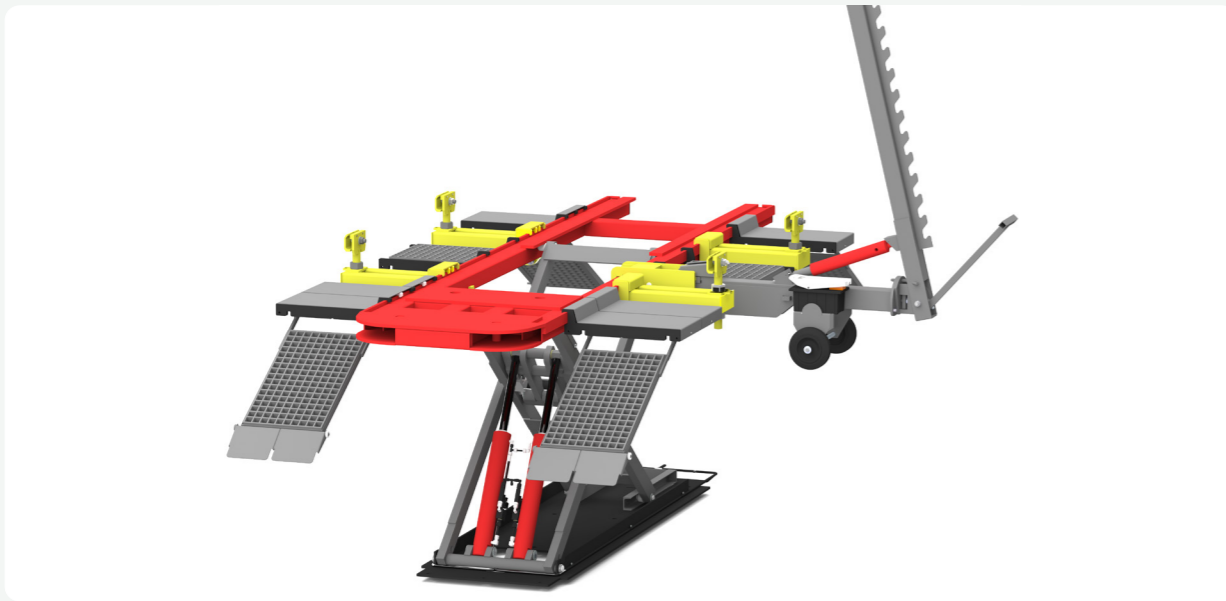

3 SÄTZE



X110.0400



XT14.0600



XT14.0613

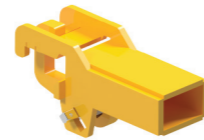

XT14.0614

2 SÄTZE



LX02.0602



XT14.0610

REFERENZNUMMER	BESCHREIBUNG
XT14.3600.x	X-TRAC RAPID
REFERENZNUMMER	ZUBEHÖR
XT14.1800.x	HEBETISCH
X110.0400	SCHWELLERKLAMMERN
XT14.0600	STARRE BELAGPLATTEN (X2)
XT14.0613	ZUGGERÄT
XT14.0614	ZUBEHÖR FÜR SEITLICHES ZIEHEN
LX02.0602	2 HEBEPLATTEN FÜR LYNX II
XT14.0610	FAHRRAMPEN

X-TRAC
OPTIONALES ZUBEHÖR

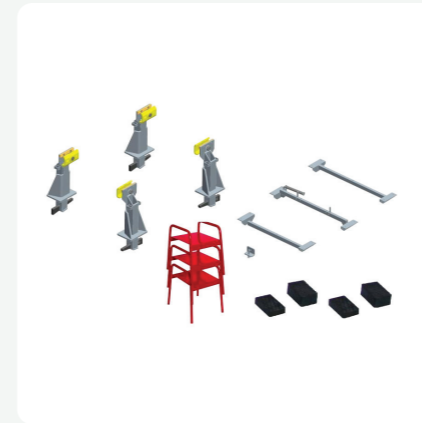

XT14.NA.001

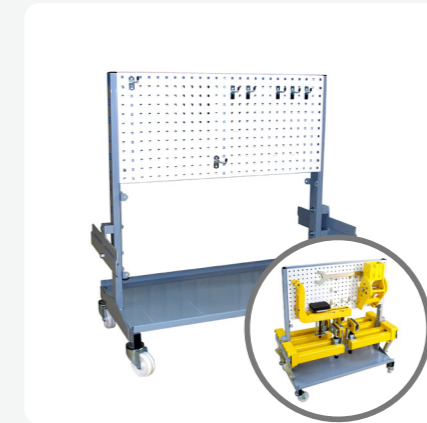

X110.0900



XT14.0611



XT14.LEV.02



XT14.LEV.04



MERCEDES & BMW

LX02.AN.001.B



RENAULT

XT14.AN.013

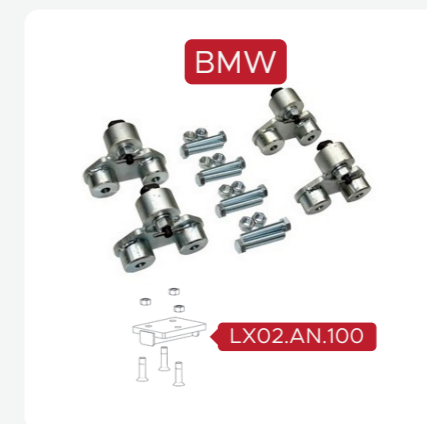

BMW

LX02.AN.100

AN.34.B

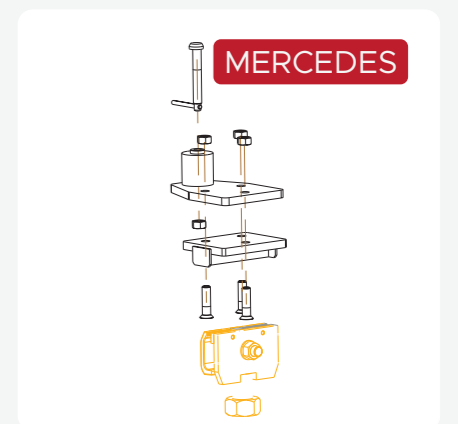

MERCEDES

AN.41.LX



CELETTE DEUTSCHLAND GMBH

EUGEN-ENSSLIN-STR.3
77694 KEHL
GERMANY

+49 785 195 58 712



CELETTE SAS

80, IMPASSE DES BRETTEAUX
42410 SAINT MICHEL SUR RHONE
FRANCE

+33 474 575 959



CELETTE NORTH AMERICA

122 VALLEY RIDGE BLVD.LEWISVILLE,
TX 75057 / USA

+1 254 382 8698



CELETTE INDIA PVT LTD.

2/122 B-1, MYLAMPATTY ROAD,
KARAYAMPALAYAM,
COIMBATORE 641062 / INDIA

+91 88 70 86 11 11



**CELETTE AUTO EQUIPMENT
AND REPARATION**

ROOM 3, 11F, XING HUI BUILDING,
NO 176, MIN YANG ROAD,
JIAXING, 31400 ZHEJIANG PROVINCE / CHINA

+86 158 8831 7667



CELETTE JAPAN TECHNICAL OFFICE

667-9 MABASHI, SHISUI-MACHI, INBA-GUN,
CHIBA 285-0914 / JAPAN

+81 70 2183 1960



CELETTE ASIA PACIFIC

700/941 M.5 AMATA CITY
CHONBURI INDUSTRIAL ESTATE,
NONGKAKHA, PHANTHONG 20160
CHONBURI / THAILAND

+66 905 630 258

INFO@CELETTE.COM | WWW.CELETTE.COM

